

CONJUNTO

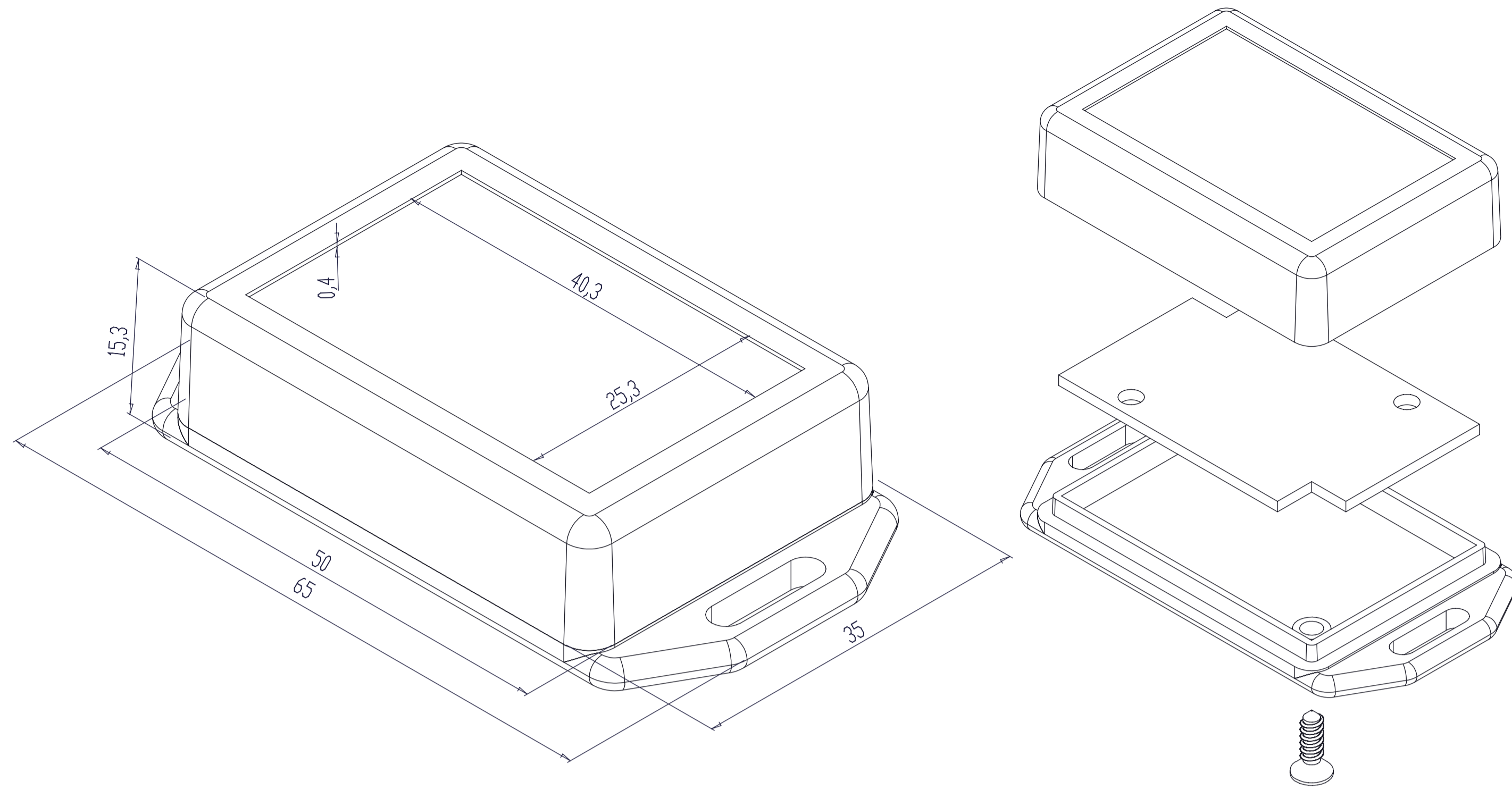

CUERPO

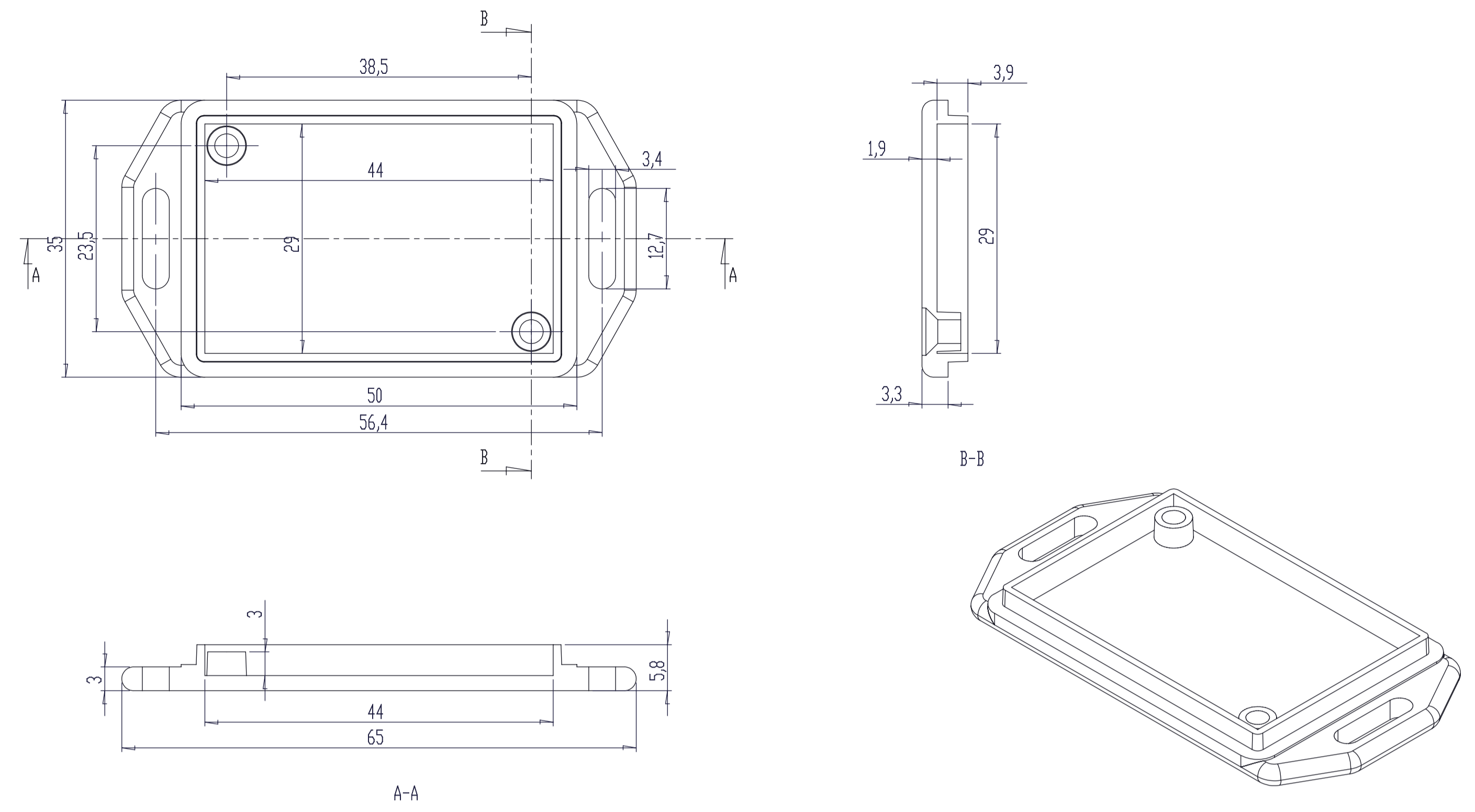

TAPA

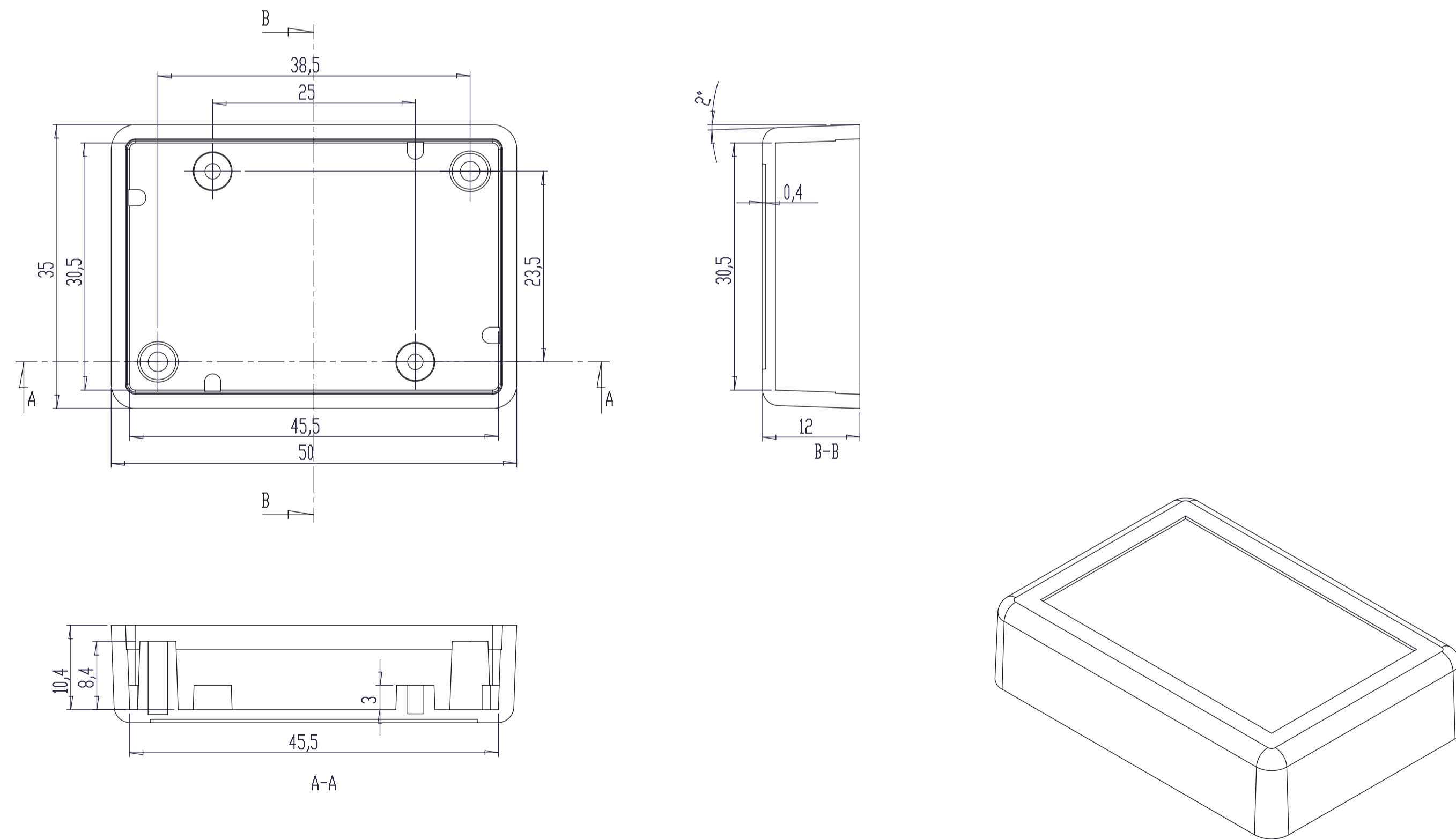

MUESTRA PCB

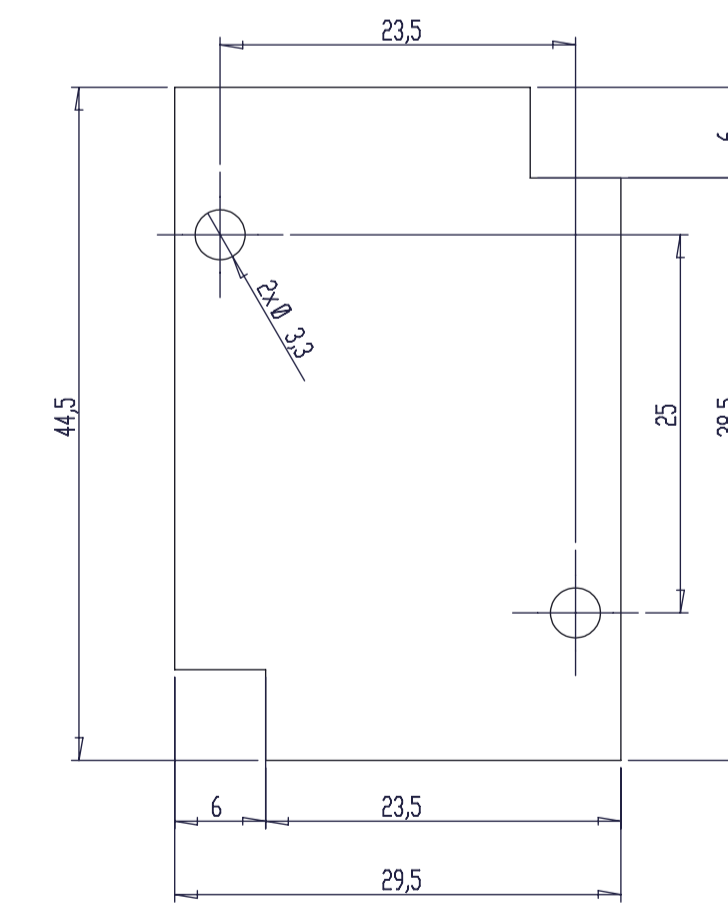

Al copiar esta información no se actualizará. Copy for information will not be updated!

SUPERTRONIC REF. **PM003** Revisión 00



www.supertronic.com supertronic@supertronic.com +34 932 980 257

