

CONJUNTO

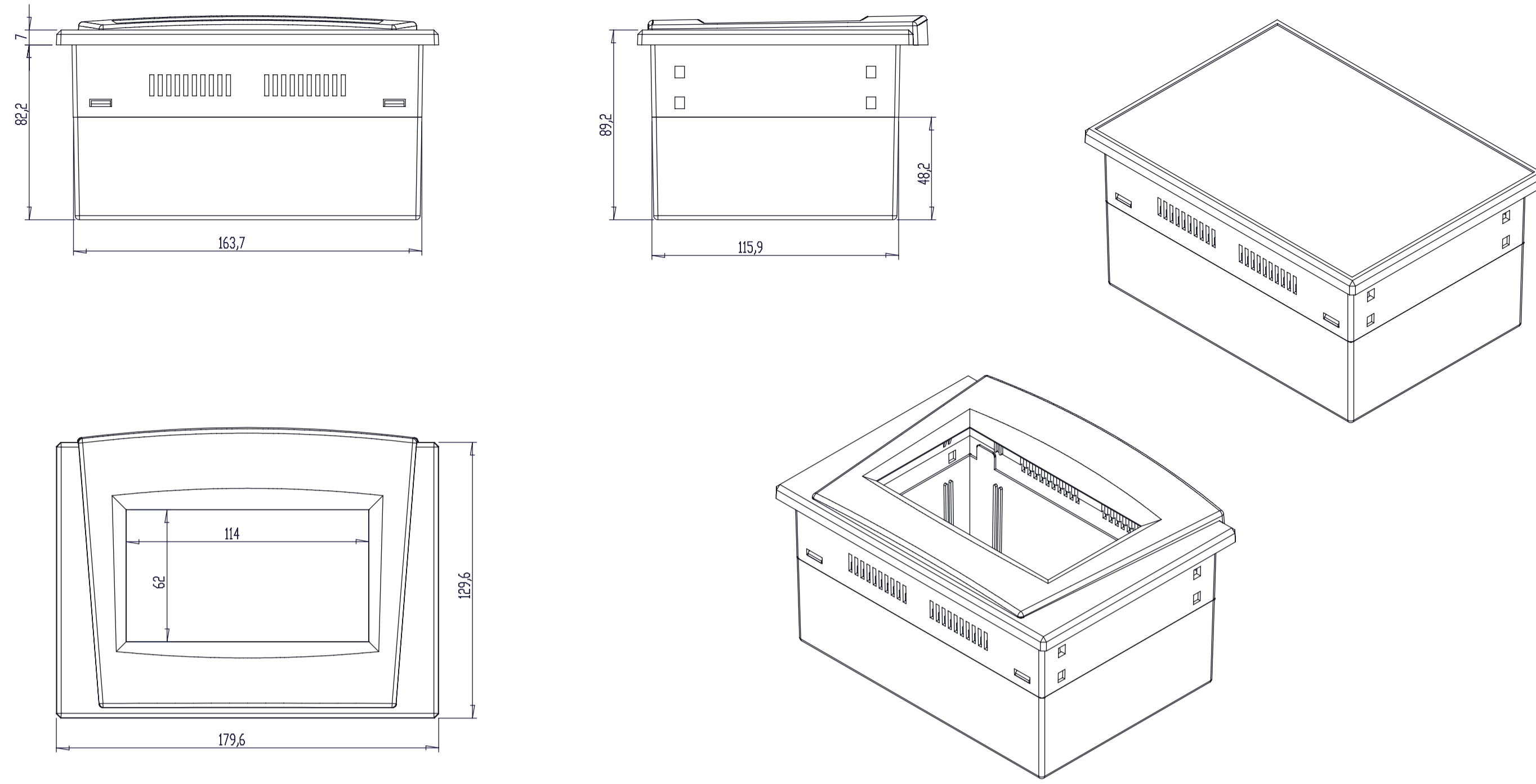

CUERPO

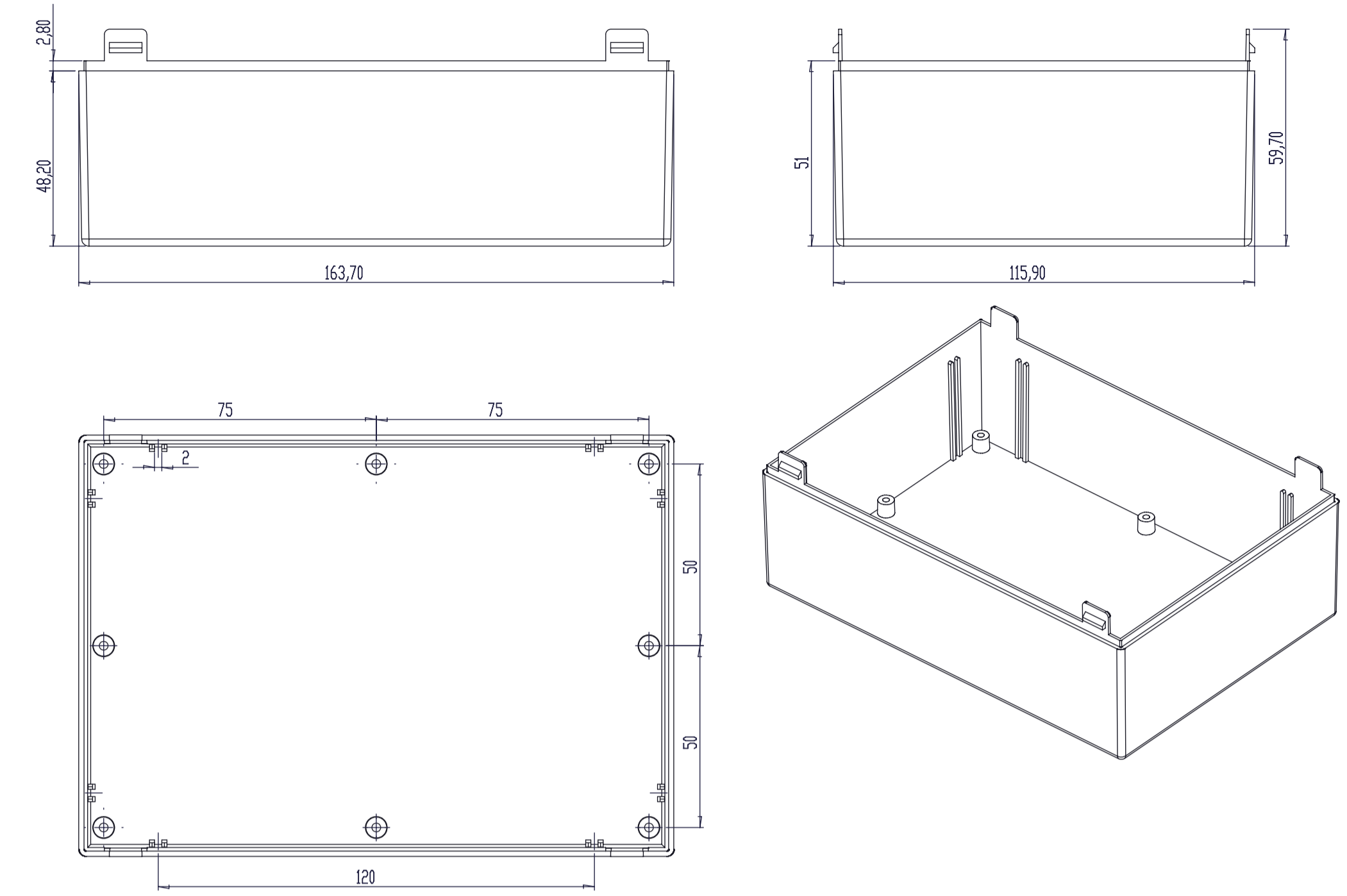

CONJUNTO V.2

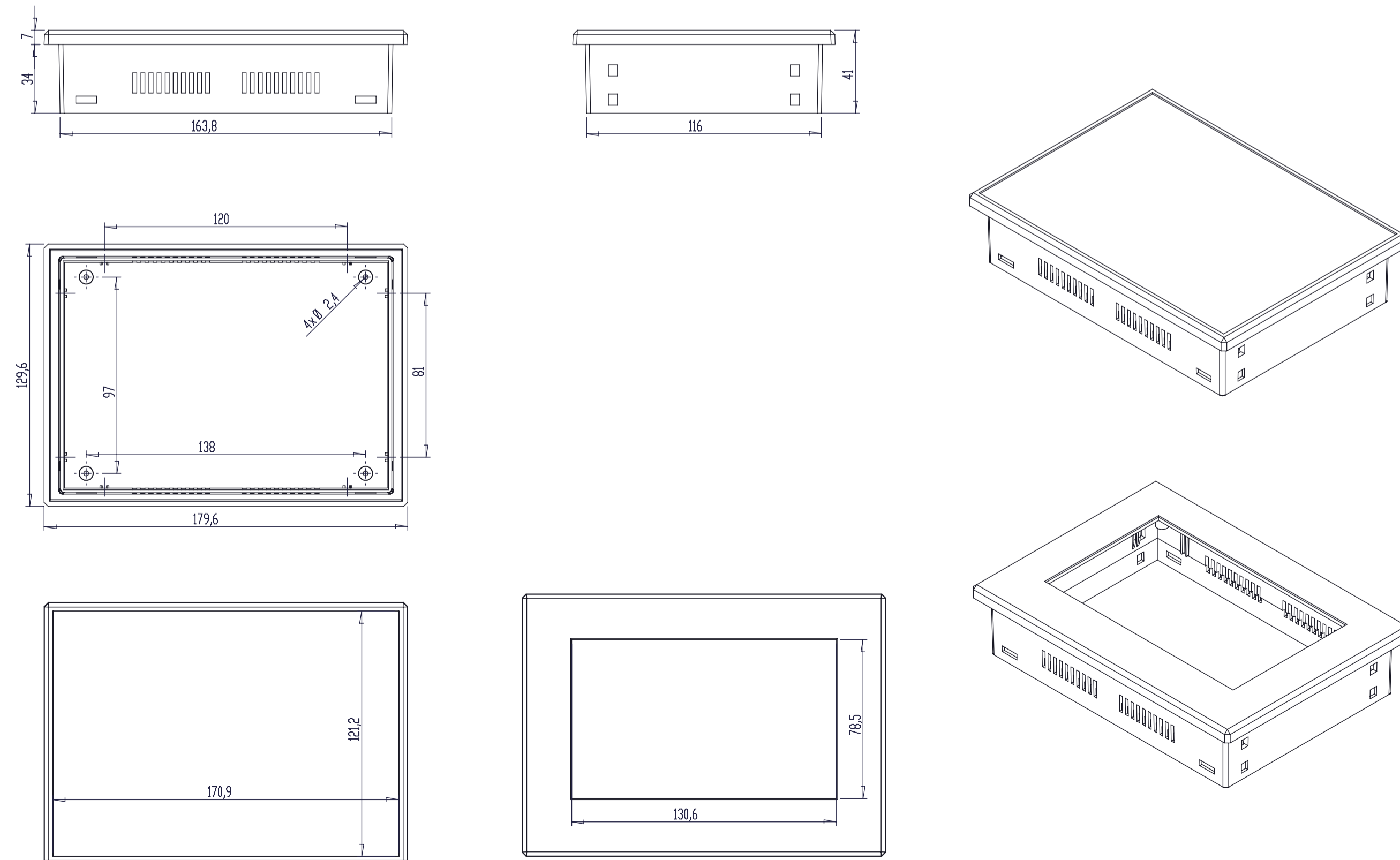

TAPA

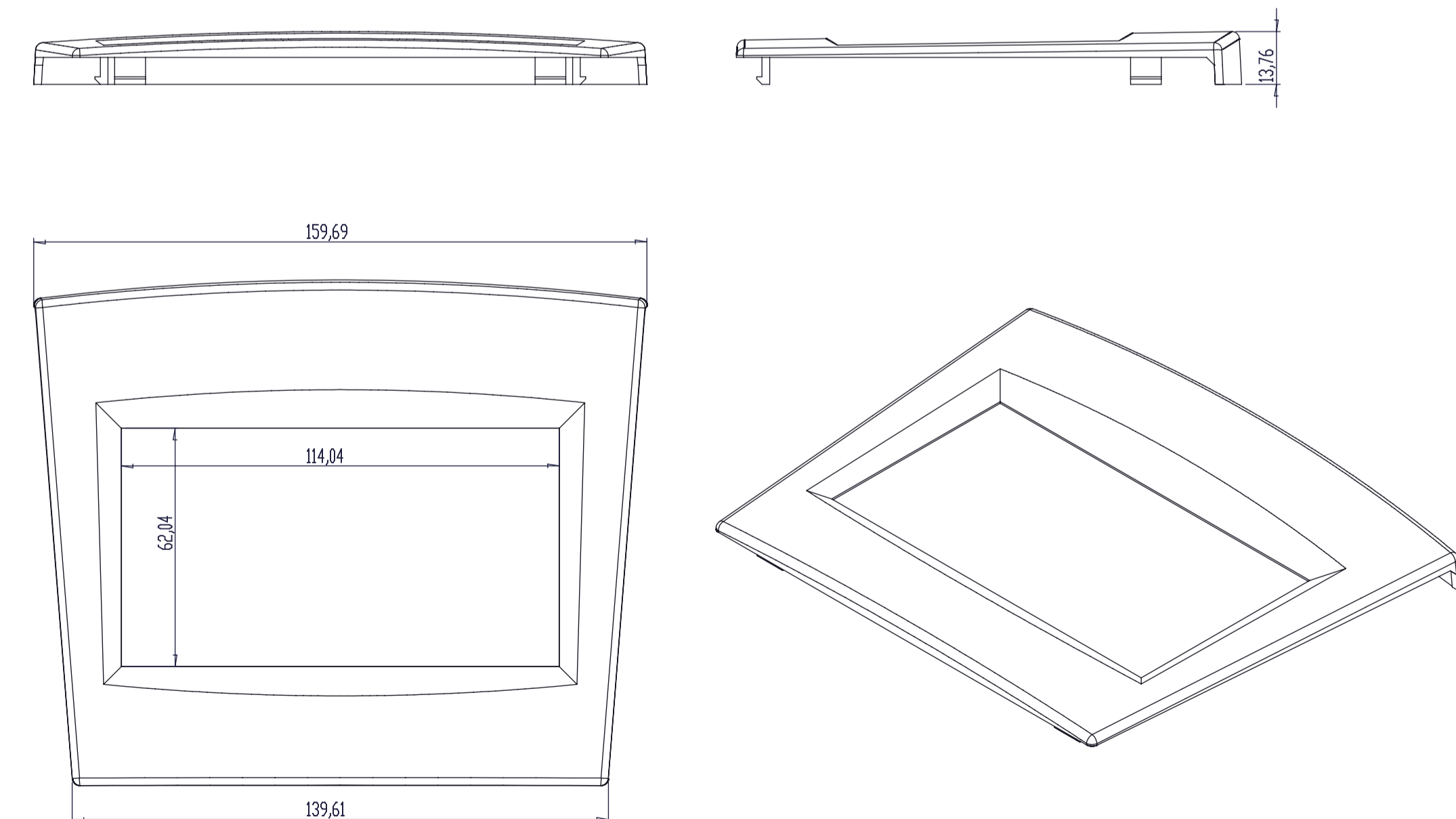

Al copiar esta información no se actualizará. Copy for information will not be updated!

SUPERTRONIC REF. PO310 Revisión 00



www.supertronic.com supertronic@supertronic.com +34 932 980 257

Firmado Signed