

CONJUNTO

CUERPO

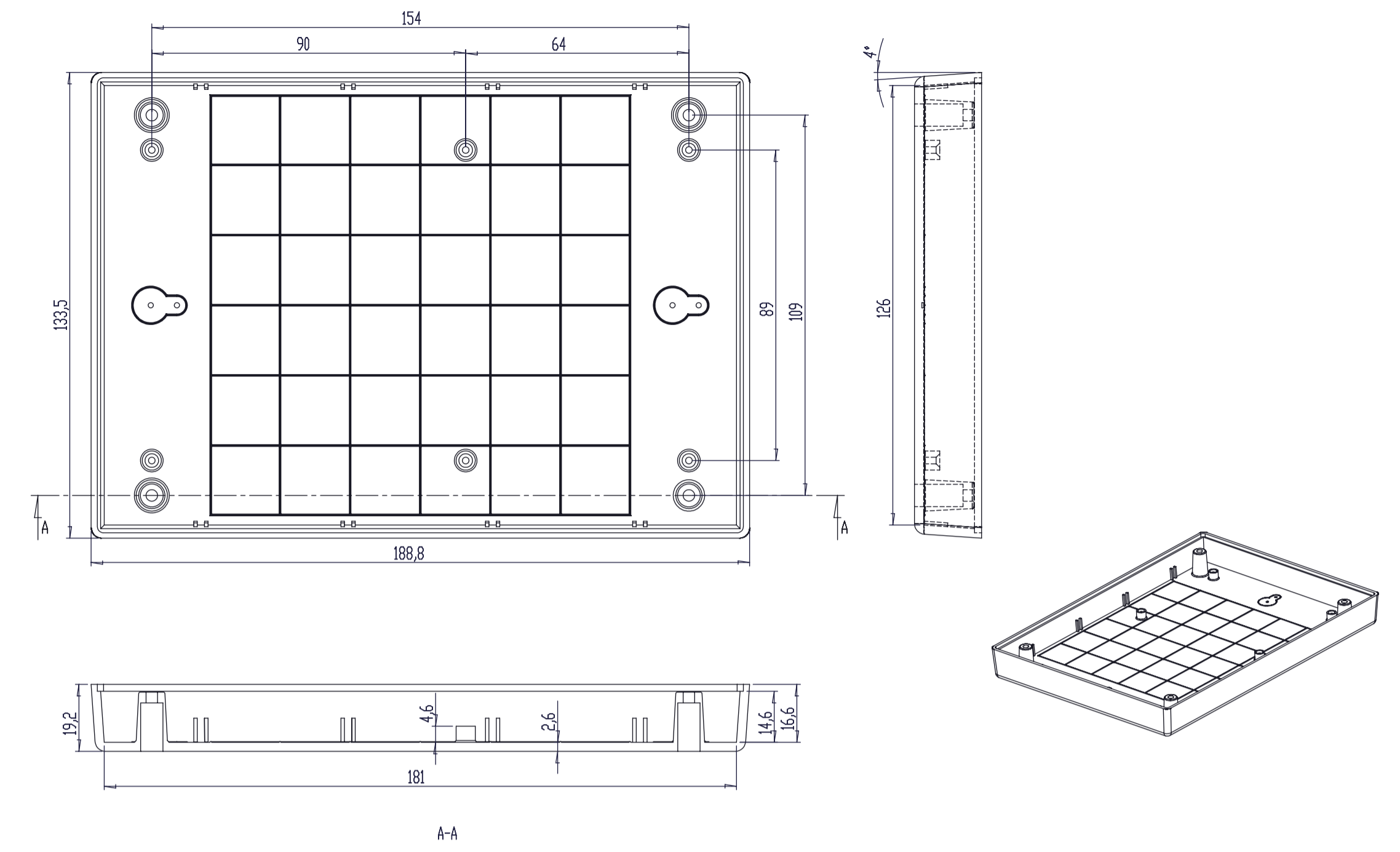
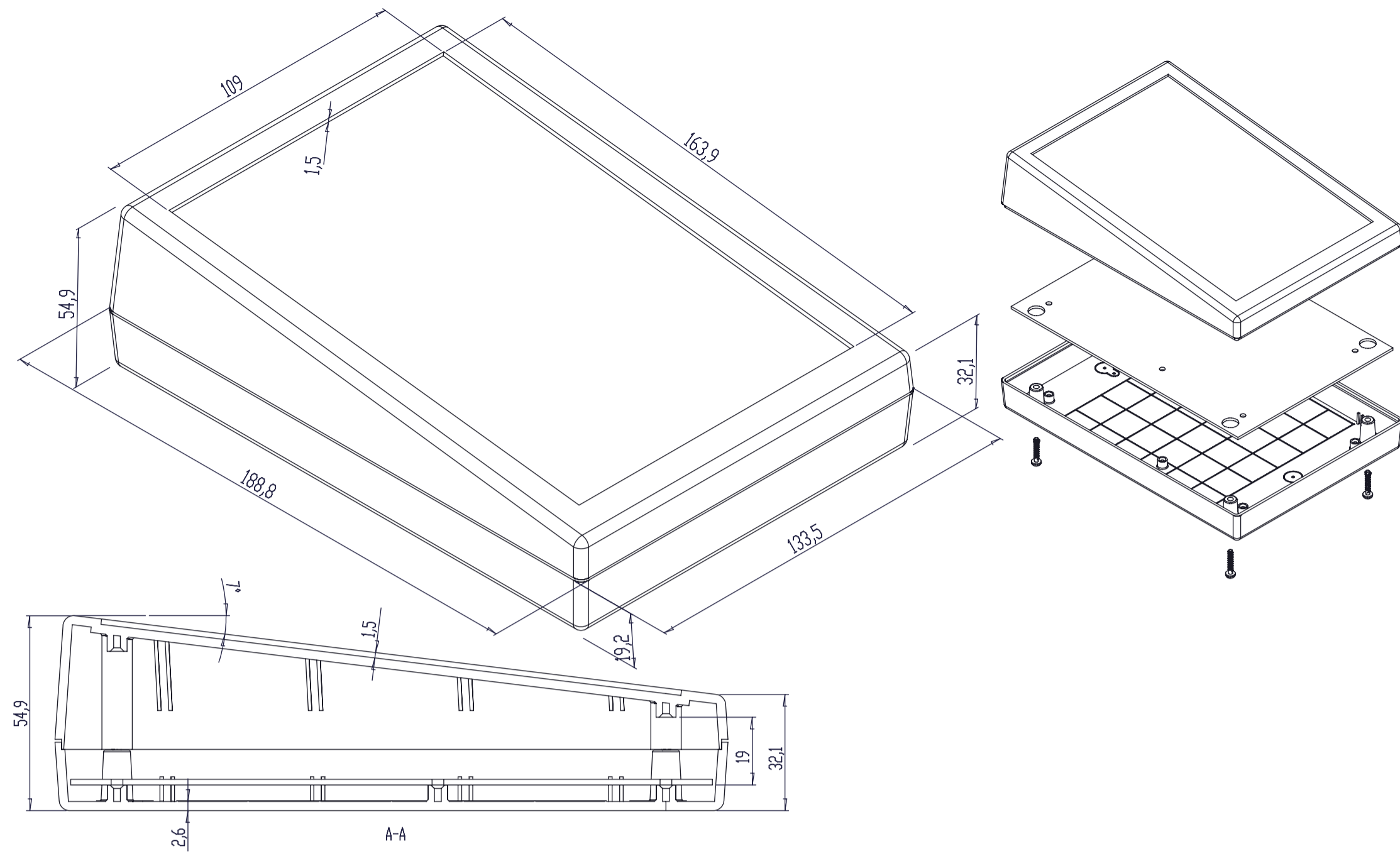

TAPA

MUESTRA PCB

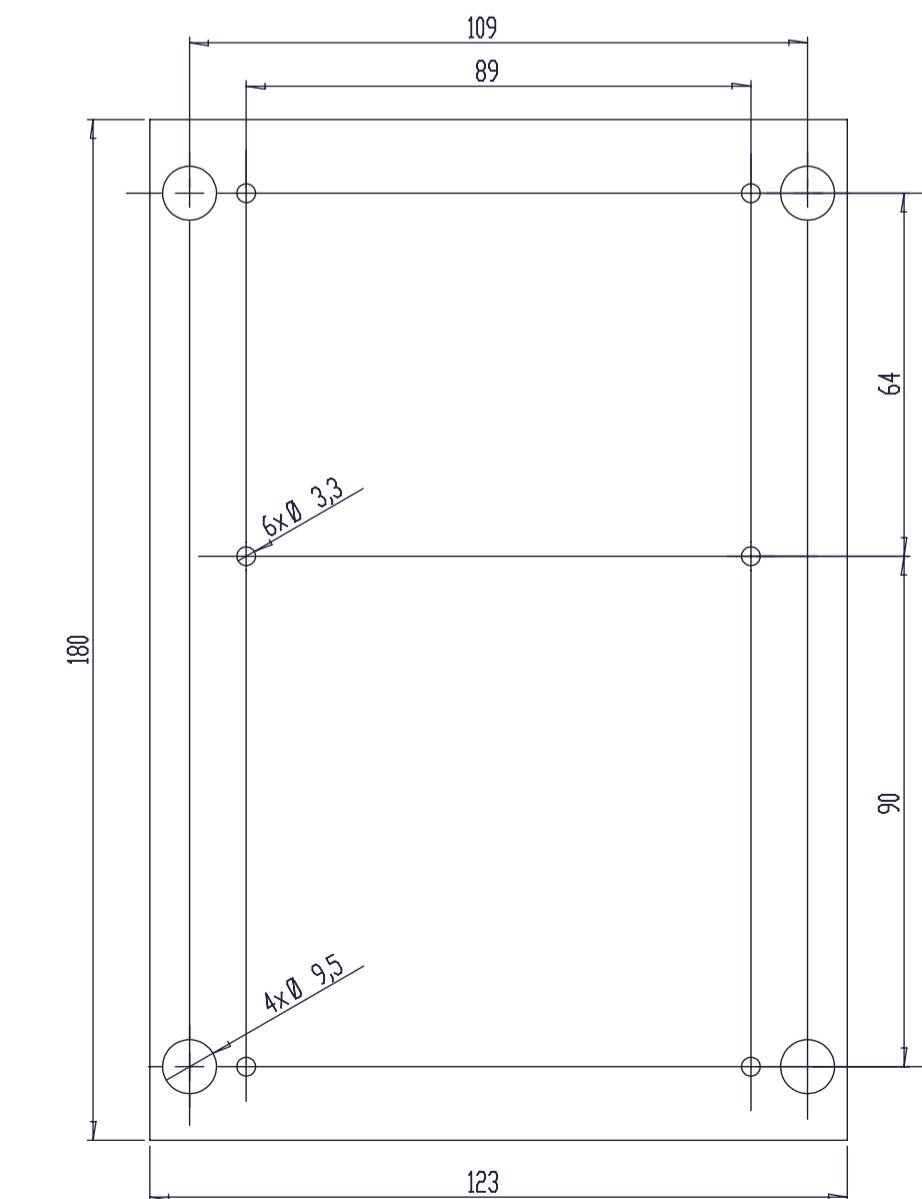
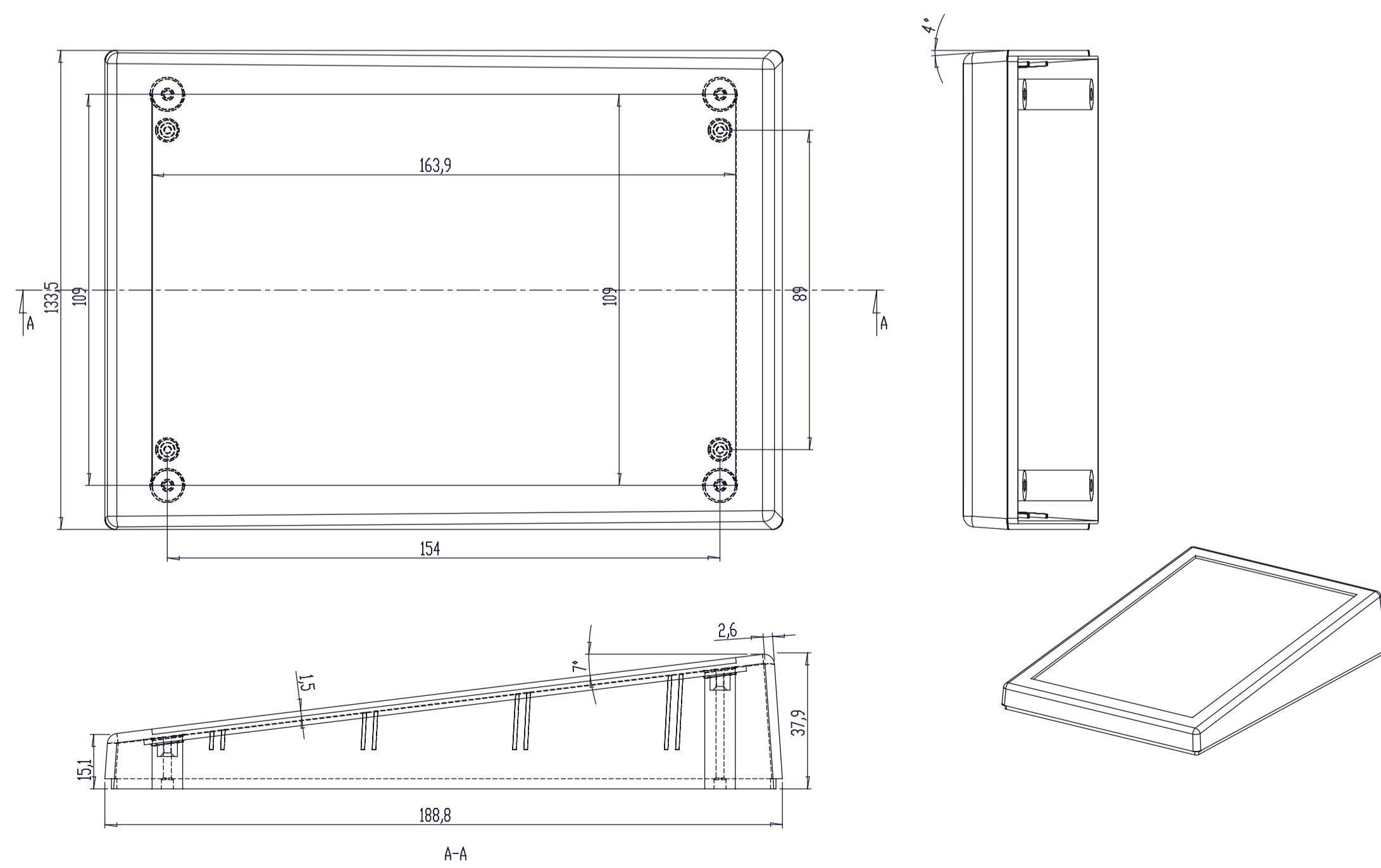

Al copiar esta información no se actualizará. Copy for information will not be updated!

SUPERTRONIC REF. PT120 Revisión 00

Version 00



www.supertronic.com supertronic@supertronic.com +34 932 980 257

